

MWS5 Product Guide

mySmart

Miniature Microwave Presence Detector (standalone)

Overview



The MWS5 series of miniature microwave presence detectors provide automatic control of lighting loads with optional manual control. As a standalone product it is designed to be fitted unobtrusively into ceiling tiles or solid ceilings using the supplied clips.

Three models are available: premium, direct dim, and analogue dim all of which will switch incandescent, fluorescent and compact fluorescent lighting. The direct dim variant controls DALI or DSI digital dimming ballasts whilst the analogue dim variant controls 1-10V dimming ballasts.

The unit detects movement using a microwave sensor and turns the load on. When an area is no longer occupied the load will switch off after an adjustable time out period.

All functionality is fully programmable using an IR handset.

Features

Sensor head

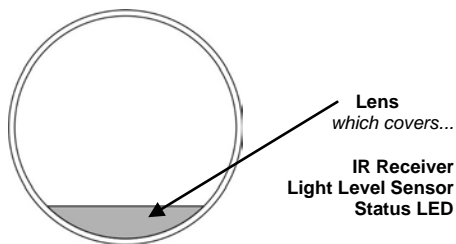

Microwave Sensor

Detects movement within the unit's detection range, allowing load control in response to changes in occupancy.

IR Receiver



Receives control and programming commands from an IR (infrared) handset.

Light Level Sensor

Measures the overall light level in the detection area

Status LEDs

The LED flashes **Red** to indicate the following:

Walk Test LED active	 when movement is detected
Valid setting received	

Power supply



Dimming version shown

RJ11 connector

The sensor head has a flying lead with a RJ11 plug at the end plugs into the RJ11 socket on the power supply.

Power supply

This power supply has a 6A relay. It also has connections for an external switch that can be used to turn on the load when absence detection mode has been set or raised / lowered with dimming variants.

Detection diagram

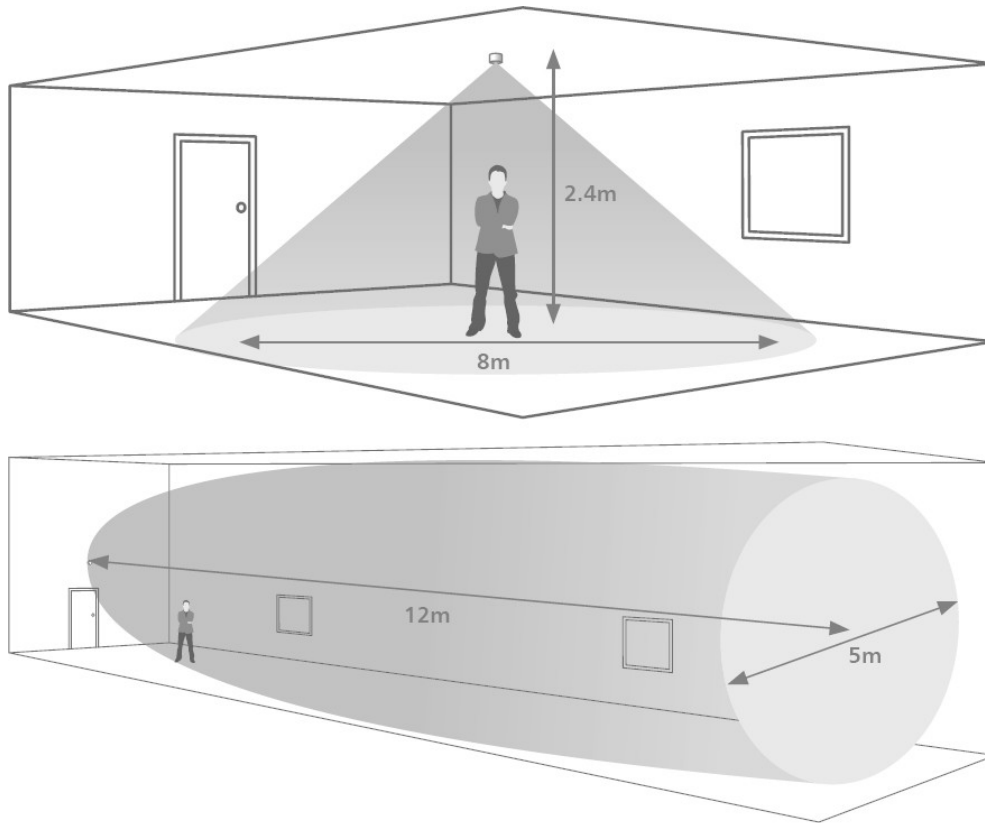

Area of high sensitivity  Area of lower sensitivity 

Please note that these approximate distances will apply with the sensitivity set to maximum.

The detector should be sited so that the occupants of the room fall inside the detection pattern shown opposite). Please note that when ceiling mounting, the recommended ceiling height of the sensor head is 2.4m.

- Avoid direct sunlight entering the sensor.
- Do not site within 1m of forced air heating or ventilation.
- Do not fix to a vibrating surface.
- Avoid metallic objects directly in front of the sensor head.
- Do not fit to a suspended luminaire.

Sensor functionality

Detection mode

- **Presence** When movement is detected the load will automatically turn on. When the area is no longer occupied the load will automatically switch off after an adjustable time period.
- **Absence** The load is manually switched on. When the area is no longer occupied the load will automatically switch off after the adjustable time period has elapsed.
 - Switch operation:
 - PRM single switch: short press turn on, long press turn off.
 - MWS5-DD & MWS5-AD single switch: short press turn on, short press turn off, press and hold cycles dimming.
 - MWS5-DD & MWS5-AD two way switch: up button short press turns on, press and hold to dims up. Down button short press turns off, press and hold dims down.

In either case, sensitivity to movement of the microwave sensor can be adjusted using the Sensitivity parameter.

HINT: To assist in setting the Sensitivity, turn on the Walk Test LED which will flash red when movement is detected.

Switch Level On/Off

Occupancy detection can be made dependant on the ambient light level using the Lux On Level and Lux Off Level parameters.

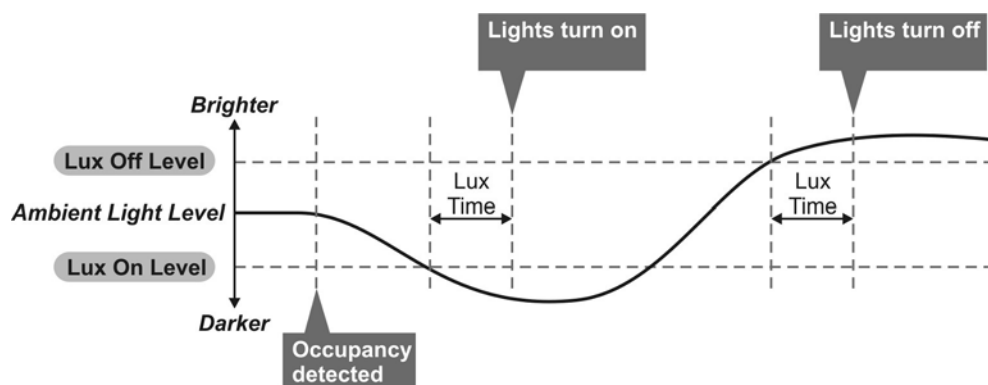

Maintained Illuminance (daylight harvesting) - DD and AD variants only

The detector measures the overall light level in the detection area and calculates the correct output for the luminaires, to achieve a preset lux level (maintained illuminance or daylight harvesting).

Burn-in - DD and AD variants only

Burn-in - DD and AD variants only

- **Overview**

It is a requirement of many fluorescent lamp manufacturers to have the lamps on at maximum output for a period of time to guarantee lamp life (refer to the manufacturer's datasheet for details). As the MWS5-DD & AD are able to dim the lamps using DALI/DSI or 1-10V, the products provide a facility to disable this for a given period of time.
- **Operation**

By setting the "Burn in" parameter, you can select a time during which the lamps are not allowed to deviate from maximum output. The unit counts the time, and even remembers how long has elapsed in the event of a power failure. To cancel the burn in function, simply select a time of 0. Note that when the lamps are changed, the burn in time should be set again.

Installation

Surface mounting using the base plate

Use the base plate for surface mounting.

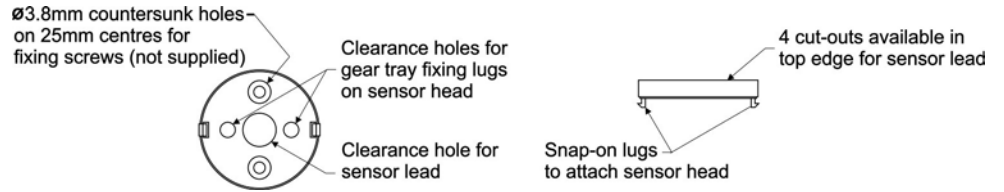

Panel mounting using lugs

Use the lugs on rear of detector to secure into thin sheet metal (1mm max.).

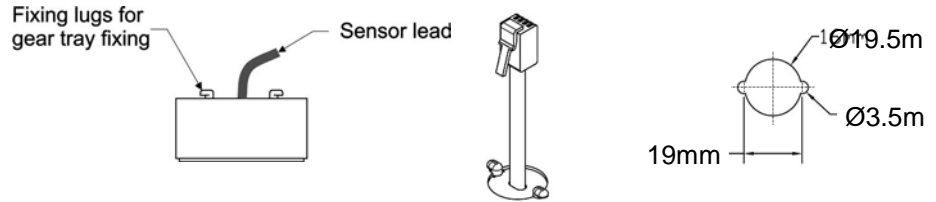

Flush mounting

The product can be mounted into a flat panel of a luminaire using the flush mount ring as shown.

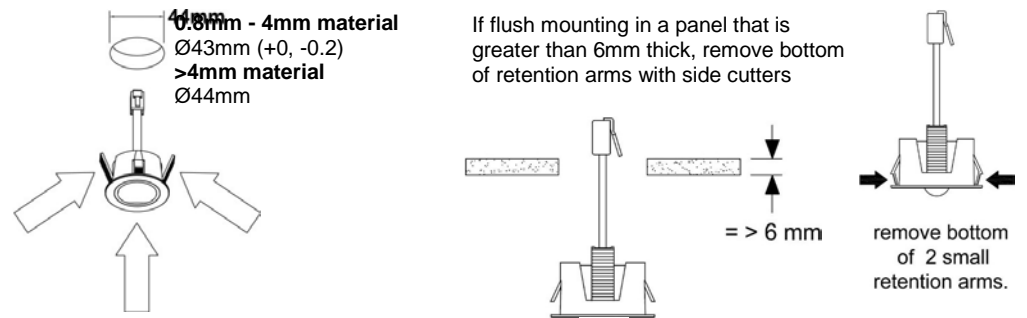

Flush fitting behind light fitting diffuser using the flange mount bracket

Glue the flange mount bracket to the rear of the diffuser, and fasten the sensor head in place using the two longer (19mm high) bracket clips.

Before gluing, please ensure that the glue used is compatible with both the acrylic flange mount bracket and the diffuser material.

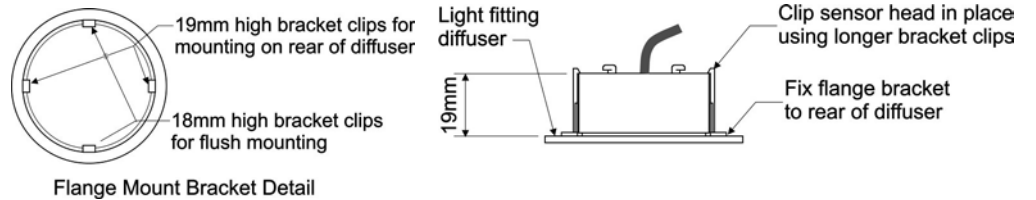

Wire the products as shown in the diagrams. All switches are optional, however the dimming variants can have two switch configurations. If used with Option A, a single momentary switch can be used for absence detection and dimming up/down—set switch mode *1 position switch together* (see page 9). If used with Option B, a centre biased momentary switch gives the benefit of having separate switches to dim up and down—set switch mode *2 position switch together* in this case.

Ensure that there terminal covers are fitted and that the cables are clamped using the integral cable clamps.

MWS5-PRM - non-dimming

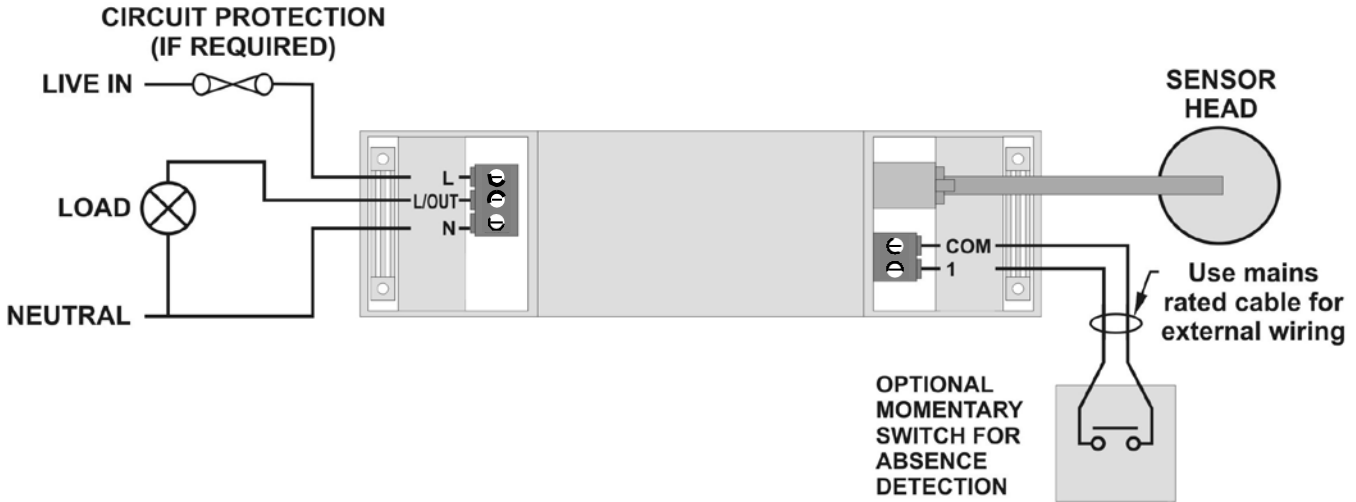

MWS5-DD, MWS5-AD Dimming - switch Option A

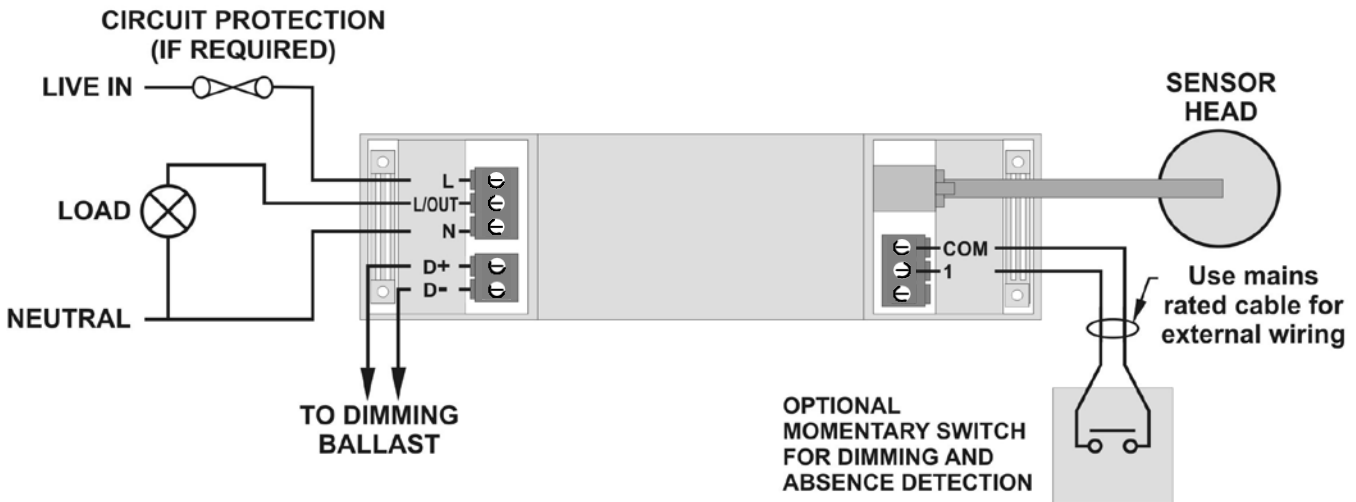

MWS5-DD, MWS5-AD Dimming - switch Option B

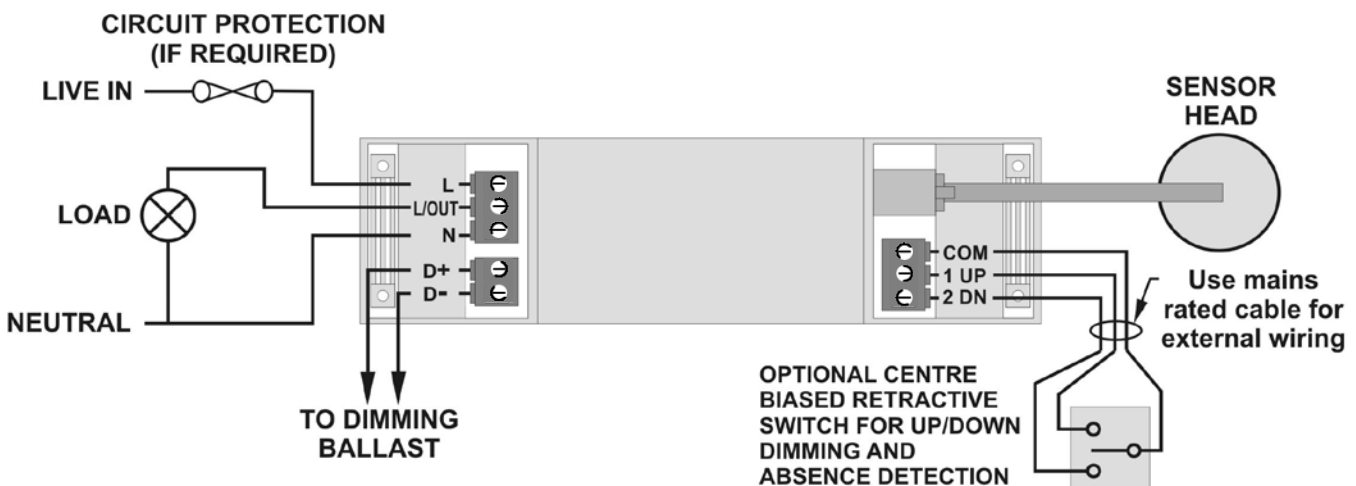

Power-up test procedure

When power is applied to the unit, the load will turn on immediately.

Set the timeout to 10 seconds, vacate the room or remain very still and wait for the load to switch off .

Check that the load switches on when movement is detected.

The unit is now ready for programming.

Fault finding

What if the load does not turn ON?

- Check that the live supply to the circuit is good.
- Check that the load is functioning by bypassing the sensor (e.g. link terminals **L** and **L/Out**).
- If the detection range is smaller than expected, check the diagram on page 2. Rotating the sensor slightly may improve the detection range.

HINT: The Walk Test LED function can be used to check that the unit is detecting movement in the required area.

What if the load does not turn OFF?

- Ensure that the area is left unoccupied for longer than the Time Out Period.
- Ensure that the sensor is not adjacent to circulating air, heaters or lamps.
- The unit may pick up movement through glass, thin partitions or walls and “false trigger”. Reduce the sensitivity using the sensitivity settings .

Readback function (only with UNLCDHS handset)

The UNLCDHS has the ability to read back the settings stored in a device.

To read back individual parameters

- Navigate to the parameter and press the ‘R’ (Read) button whilst pointing at the device. The handset will click when the parameter has been read back, the device will flash its LED, and the value will be shown against the parameter in the menu.

To read back all of the parameters in a menu

- Press and hold the ‘R’ (Read) button for more than 1 second.
- The handset will click every time a parameter is received
- The device will show multiple flashes of its LED
- All of the values will be shown against the parameters in the menu.
- The individual parameters may be edited and then saved as a ‘Macro’.

Notes

- *If a parameter(s) has been missed because of a communication error, the missing value(s) is replaced by dashes.*
- *When reading back, the Channel 1 relay (where fitted) will temporarily be switched off, and will return to it’s normal state 2 seconds after the read back has been completed.*

Basic programming - PRM, DD and AD variants



The functionality of the MWS5-PRM, DD & AD are controlled by a number of parameters which can be changed or programmed by any of the following devices:

















- **UHS5** Infrared Handset. See below for programmable functions.
- **UNLCDHS** Infrared Handset (with LCD). See user guide for full programming details.

For most basic programming operations the UHS5 handset can be used and the following procedures are based on using this device.

Point the handset at the Sensor and send the required programming commands to the unit as shown below.

Valid commands will be indicated by a red LED flash. See page 1 for details of other LED responses.

Note: other functions on the UHS5 which are not shown below are not applicable to this product.

Parameter Name	Default Value	Number of Shift key presses				UHS5 Handset Graphics	Description
		0  SHIFT 1 SHIFT 2	1  SHIFT 1 SHIFT 2	2  SHIFT 1 SHIFT 2	3  SHIFT 1 SHIFT 2		
Button Activation							
On / Raise		On	Raise				Turn lights on or to raise lights.
Off / Lower		Off	Lower				Turn lights off or to lower lights.
Walk test	Off	On	Off				When set to On this causes a red LED to flash on the sensor when it detects movement. Use this feature to check for adequate sensitivity levels.
Time Out (Time adjustment)	20 mins	1, 10 & 20 minutes	5, 15 & 30 minutes	10 seconds			Once the detector is turned on, this value sets how long the lights will stay on once movement has ceased.
Lux on level (Switch level on)	9	2, 5 & 7	4, 6 & 9				Lux level setting to prevent the luminaires being switched on if the ambient light level is sufficient (adjustable between 1 and 9). The luminaires will always be switched on at level 9.
Light Level (DD & AD only)	6 (600)			2 (200) 5 (500) 7 (700)	4 (400) 6 (600) 9 (999)		Sets a target light level to be maintained by the lighting system. 9 (999) = disabled.
Lux off level (Switch level off)	9	2, 5 & 7	4, 6 & 9				Lux level setting to switch the luminaires off during occupancy if the ambient light level goes above the setting (adjustable between 1 and 9). Level 9 will always keep the lights on. This setting can be used for "window row switching". <i>Note: the Lux Off Level value must always be greater than the Lux On Level value.</i>
Load Type (DD only)	DALI			2-DALI 7-DSI	2-DALI on		Sets the ballast control protocol to be used by the output channel.
Sensitivity	9	1, 5 & 9	3, 6 & 8				Sensitivity level for detecting movement. 1 = low sensitivity 9 = high sensitivity
Defaults				D			Returns the unit to the default settings.
Burn-in (DD & AD only)	0	0	50	100			Determines how long the output will be at 100% so that lamps 'burn-in'. The 'burn-in' time is not affected by power supply interruptions.
Presence / Absence	Presence	Presence	Absence				Presence mode allows the output to turn on when movement is detected and off when movement ceases. Absence mode allows the output to turn off when movement ceases, but must be manually turned on first.
Shift							Use this button to select the settings in red and blue signified by the 'Shift 1' and 'Shift 2' LEDs

Advanced programming

Parameter Name	Default Value	Range / Options	Description	UHS5	UNLCDHS
Detector Parameters					
Walk Test LED	Off	On or Off	When set to On this causes a red LED to flash on the sensor when it detects movement. Use this feature to check for adequate sensitivity levels.	✓	✓
Time Out (Time adjustment)	20 minutes	0-99 minutes	Once the detector is turned on, this value sets how long the lights will stay on once movement has ceased. Select 0 for 10 second delay – use for commissioning only.	✓	✓
Manual Time Out	10 minutes	0-99 minutes	When a manual operation occurs, either via the switch input or the infrared, it invokes the timeout period. Example 1: a detector in presence mode has a detector timeout of 15 minutes and a manual timeout of 3 minutes. When the user leaves the room they press the off button. The sensor will revert to automatic after 3 minutes, and then walking back in the room will turn the lights on. Example 2: using the settings above, the user turns the lights off (say for a presentation) but stays in the room. Every time a movement is detected, the manual timeout period is re-triggered, but when it doesn't pick up for the short timeout period, the sensor will timeout and revert to automatic. This means the lights may turn on inadvertently during the presentation, if the occupants are still for the manual timeout period, so adjust the timing carefully.	✗	✓
Sensitivity On	9	1 (min) to 9 (max)	Sensitivity level for detecting movement when the detector is already on. *UHS5 sets Sensitivity On and Off to the same value.	✓*	✓
Sensitivity Off	9	1 (min) to 9 (max)	Sensitivity level for detecting movement when the detector is off. *UHS5 sets Sensitivity On and Off to the same value.	✓*	✓
Lux time	0	0 (disabled) 1-99 minutes	If the detector measures the lux level and decides that the output needs switching on or off as a consequence, the lux time must elapse first. If at any time during the timed delay the lux change reverses then the process is cancelled. Lux Time enables absence detection to be implemented with a lux off level set. When the button is pressed, the lights will go on, regardless of ambient light level. However, if there is sufficient ambient light, they will turn off again after the Lux Time. <i>Note that whenever the an external switch is pressed, whether in absence or presence mode, if the lights were out because of the lux level, they will be immediately turned on again for at least the Lux Time.</i>	✗	✓
Power Up State	On	On or Off	Select No for a 30 second delay on start up. If Yes is selected, there will be no delay on start up and the detector will always power up detecting.	✗	✓
On Delay	0 minutes	0-99 minutes	The On Delay to allows the first channel to switch on after the second channel. A typical application for this would be where a detector is controlling lighting and air conditioning in an area. When the occupant is detected, the lighting will be turned on immediately, whereas the air conditioning may be turned on after 15 minutes. If the area is vacated and the detector times out before the delay, then the air conditioning would never go on. The delay can be set only for channel 1 using the on delay parameter.	✗	✓
Factory default	-	-	Restores factory default settings	✓	✓

Channel Modes					
Switch only	N/A	-			
Switch and dim together	Default	-	The detector will switch and dim the lighting together.	✗	✓
Switch and dim separate	N/A	-			

User Modes					
Raise (DD & AD only)	-	-	Increase light level. Reverts when occupancy cycle complete.	✓	✓
Lower (DD & AD only)	-	-	Decrease light level. Reverts when occupancy cycle complete.	✓	✓
Override On	-	-	If the lights are off, sending the IR command will turn them on immediately and revert to automatic operation using the manual timeout period.	✓	✓
Override Off	-	-	If the lights are on, sending the IR command will turn them off immediately. After the manual timeout period (described above), the sensor will revert to automatic.	✓	✓
Cancel	-	-	Cancels the on or off override, returning the detector to normal operation.	✗	✓

Advanced programming

Parameter Name	Default Value	Range / Options	Description	UHS5	UNLCDHS
Channel 1 –Switching Channel					
Detection Mode	Presence	Presence or Absence	Presence mode allows the output to turn on when movement is detected and off when movement ceases. Absence mode allows the output to turn off when movement ceases, but must be manually turned on first.	✓	✓
Lux on level (Switch level on)	9	1 to 9 For a higher resolution a scale of 101-199 is available	Sets a minimum light level below which the microwave sensor is enabled, allowing lights to be turned on by movement. <i>Note: the Lux Level Off value must always be greater than the Lux Level On value.</i>	✓	✓
Lux off level (Switch level off)	9	1 to 9 For a higher resolution a scale of 101-199 is available	Sets a maximum light level above which the microwave sensor is disabled, preventing lights from being turned on by movement.	✓	✓

Channel 2 -Dimming Channel (DD & AD only)					
Detection Mode	Presence	Presence or Absence	Presence mode allows the output to turn on when movement is detected and off when movement ceases. Absence mode allows the output to turn off when movement ceases, but must be manually turned on first.	✓	✓
Lux on level (Switch level on)	9	1 to 9 For a higher resolution a scale of 101-199 is available	Sets a minimum light level below which the microwave sensor is enabled, allowing lights to be turned on by movement. <i>Note: the Lux Level Off value must always be greater than the Lux Level On value.</i>	✓	✓
Lux off level (Switch level off)	9	1 to 9 For a higher resolution a scale of 101-199 is available	Sets a maximum light level above which the microwave sensor is disabled, preventing lights from being turned on by movement.	✓	✓
Light Level (maintained illuminance)	600	1 to 998 (999 disabled)	Sets a target light level to be maintained by the lighting system.	✓	✓
Load Type (DD only)	DALI	DSI DALI DALI On	Sets the ballast control protocol to DSI. Sets the ballast control protocol to DALI. DALI On provides a permanent voltage to DALI ballasts when DALI has not been implemented correctly in the ballast. Maximum number of ballasts is 4 unless the relay is disabled then it is 10.	✓ ✓ ✗	✓ ✓ ✓
Max Value	100%	0 to 100%	Maximum dimming output level.	✗	✓
Min Value	0%	0 to 100%	Minimum dimming output level.	✗	✓
On value	99	0 to 99	Dimming output level when switched on (0-99).	✗	✓
Off value	0	0 to 99	Dimming output level when switched off (0-99). If a non-zero off value is set, then the output will toggle between this value and completely off depending on the switch level on and off values. For example, if it is light outside, the fittings will be off if there is no occupancy. If it is dark outside, they will adopt the preset off value. This feature is only enabled if 'Min value' is set to 99.	✗	✓
Burn-in	0	0 (disabled) or 1 to 999 hours	Determines how long the output will be at 100% so that lamps 'burn-in'. The 'burn-in' time is not affected by power supply interruptions.	✓	✓
Fade value	10	0 to 99	After occupancy ceases, this dimming output level is loaded for the fade time (adjustable between 0 and 99).	✗	✓
Fade mins	0	0 to 99	This is the time period (adjustable between 0 and 99 minutes) that the luminaire will be held at the fade value before turning off. A value of 0 disables the fade function.	✗	✓
Speed On	40	Measured in 0.1 sec intervals.	Determines the dimming response speed after the setup time has finished.	✗	✓
Speed Set	5	Measured in 0.1 sec intervals.	Determines the dimming response speed during the set up time. Measured in 0.1 sec intervals. If set to 0 will disable dimming for "Set seconds" below, used if fittings are required to warm up before dimming.	✗	✓
Set Seconds	120	1 to 999 seconds	Determines how long the dimming response set-up period lasts on power-up or on setting change. This enables the desired lux level to be achieved rapidly when the lights come on, or during setup.	✗	✓

Switch Modes					
2 position switch together (DD & AD only)	Default	-	A single centre biased retractive switch will be used to control both channels together.	✗	✓
2 position switch separate	N/A	-			
1 position switch together (DD & AD only)	-	-	A single position retractive switch controls both channels together.	✗	✓
1 position switch separate	N/A	-			

Dimensions

Sensor head

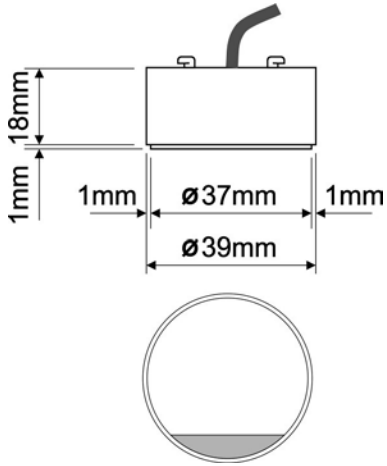

Power supply

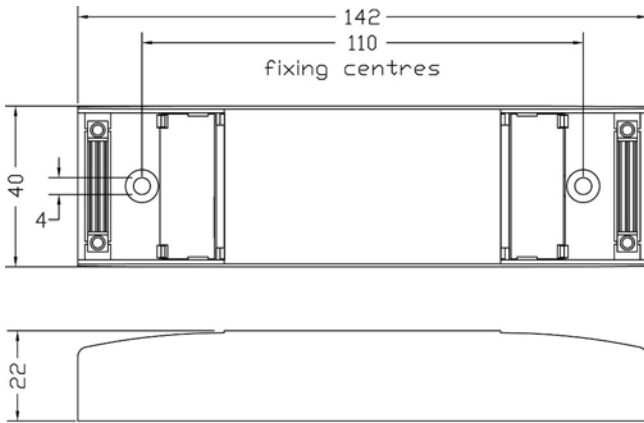

Brackets

Flange mounting bracket

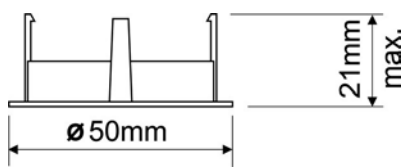

Flush ring

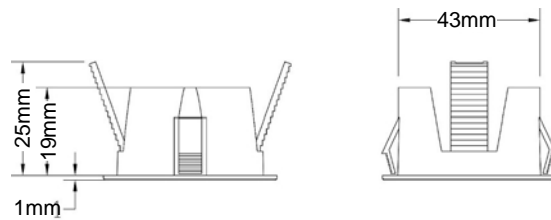

Base plate

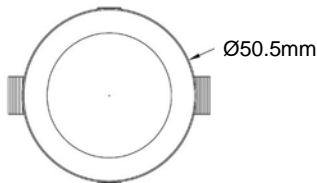
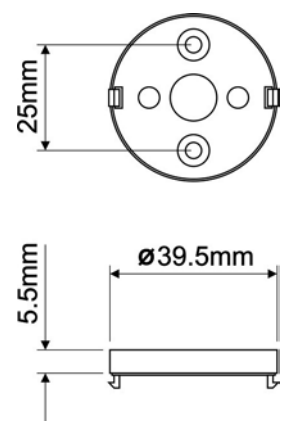

This page intentionally left blank

Technical data

Dimensions	See diagrams on page 9	Temperature	-10°C to 80°C
Weight	Head: 0.02kg Power supply: 0.08kg	Humidity	5 to 95% non-condensing
Supply Voltage	230VAC +/- 10%	Material	Sensor head, side mounting bracket - PA (polyamide)
Frequency	50Hz		Power supply - PA (polyamide)
Maximum Load	6A resistive and incandescent lighting 6A fluorescent lighting 3A compact fluorescent lighting 3A low energy lighting 3A low voltage lighting (switch primary of transformer) Fluorescent lighting (max 6 fittings recommended). For fluorescent lighting total power factor correction capacitance must not exceed 40µF 3 A fans and ventilation equipment Switch SON lighting loads via a contactor. Number of ballasts (DD & AD) Up to 10 dimming ballasts	Type	Flush holder - Flame retardant ABS
Power consumption	PRM On 1800mW, Off 1800mW DD On 1500mW, Off 868mW AD On 1100mW, Off 830mW	IP rating	Lens surround - PMMA (Clear acrylic)
Terminal Capacity	1.5mm ²	Compliance	Class 2 IP40 EMC-2004/108/EC LVD-2006/95/EC
Dimming output	Basic insulation only. Although lowvoltage, this is not an SELV output and should be treated as if mains potential. Use mains rated wiring.		



Part numbers

	Part number	Description
Complete kits	MWS5-AD-SA-C MWS5-DD-SA-C MWS5-PRM-SA-C	Miniature microwave Direct Dim Analogue 1-10V standalone complete kit Miniature microwave Direct Dim DALI/DSIstandalone complete kit Miniature microwave premium standalone complete kit
Accessories	UHS5 UNLCDHS	Programming IR handset Universal LCD IR handset

IMPORTANT NOTICE!

This device should be installed by a qualified electrician in accordance with the latest edition of the AS/NZS Wiring Rules and any applicable Building Regulations.

mySmart

Unit 16
1 Talavera Road
Macquarie Park, NSW 2112
Australia
T: 1300 697 627
F: (02) 9887 1333
www.mysmart.com.au